

GENERAL CATALOGUE

*HIGH
PRESSURE
PUMPS
H SERIES*



 **HPP**
HIGH PRESSURE PUMPS





TECHNICAL DETAILS

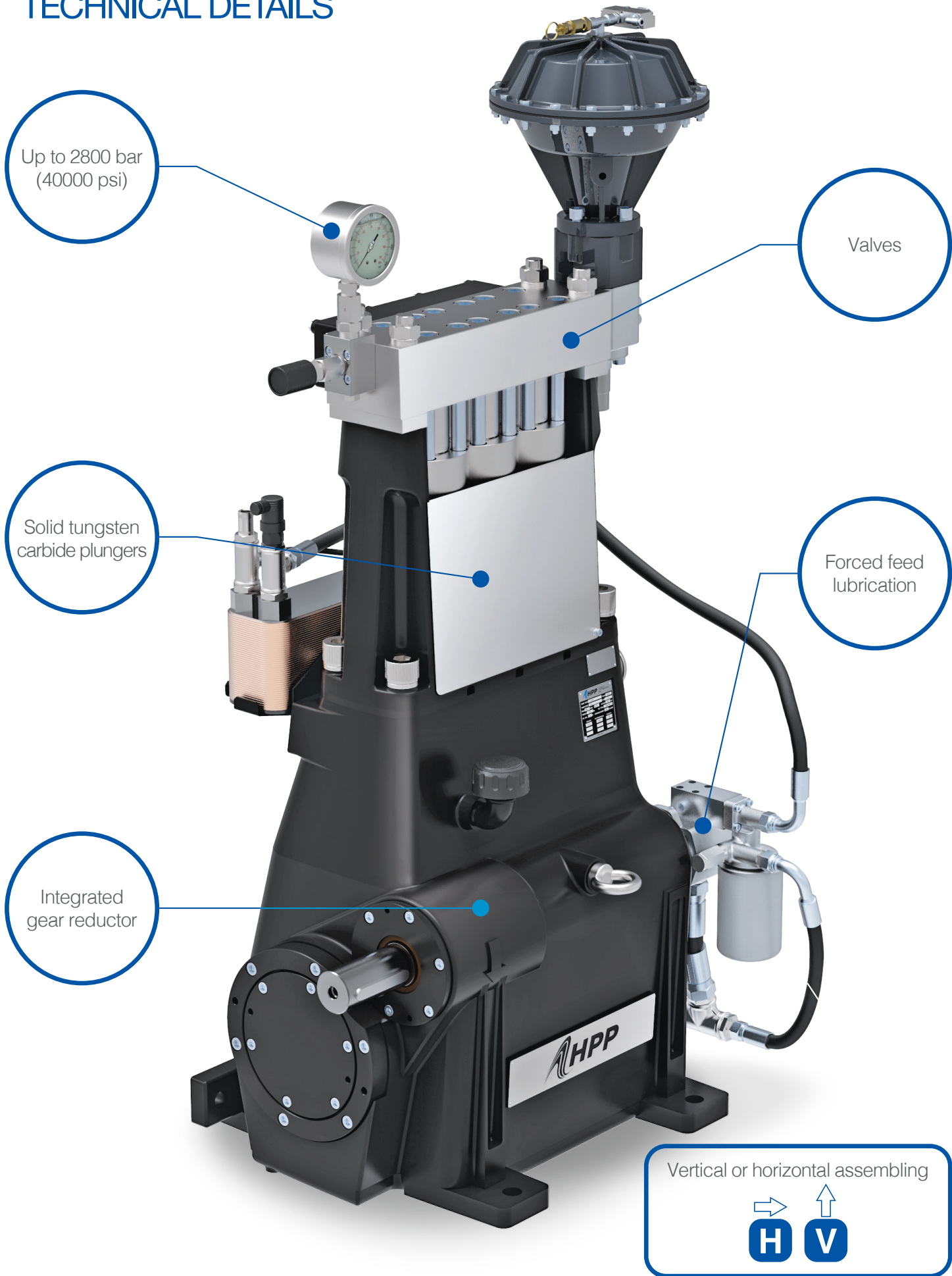

Up to 2800 bar
(40000 psi)



Valves

Solid tungsten
carbide plungers

Forced feed
lubrication

Integrated
gear reductor

Vertical or horizontal assembling

 

GENERAL NOTE: All specifications are not binding.
The Company reserves the right to change technical and aesthetics specifications without notice.

H SERIES

New series of high pressure pumps

HPP is a Comet SpA brand specialized in the design and construction of plunger pumps for water, made even better thanks to its technological expertise and further boosted by modern day technologies. This means the company is able to offer a wide range of products to meet requirements that go from 50 to 550 kW with pressures up to 2800 bar.

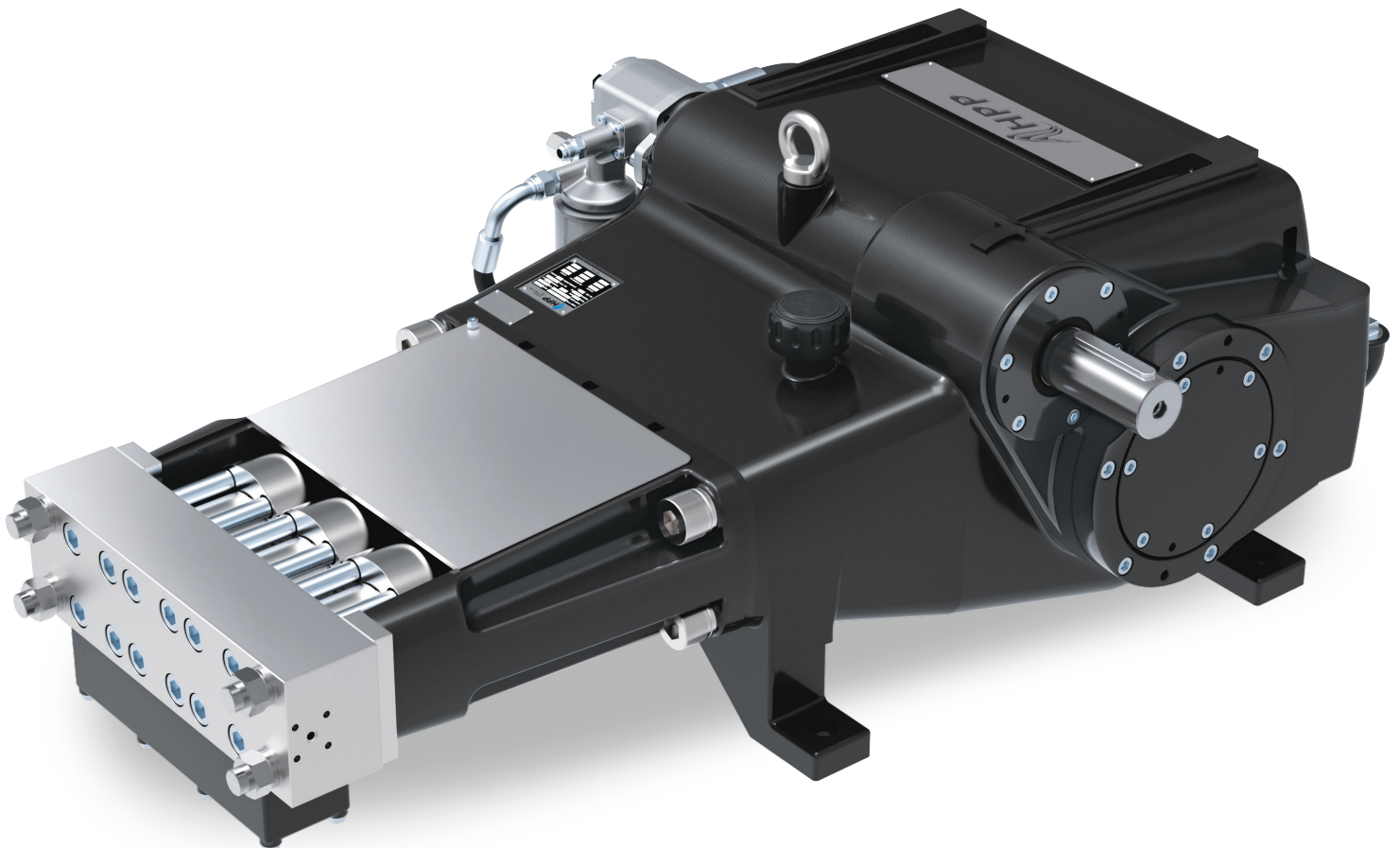

HPP pumps are manufactured using the most modern technologies both as regards to the materials used machining and mechanical operations and heat treatments. Comet is also able to provide a wide range of accessories, suitable for the specific needs of the single user. Professionalism and research make it a dynamic modern company intent on tackling and resolving the problems of a fast-evolving market.

INTELLIHEAD

IV GENERATION HEADS WITH INTELLIVALVE TECHNOLOGY

- New IV generation heads for SAP & UAP pumps
- System equipped with single-block valve mechanism
- Fewer components (-88%) than previous generation
- Less time (-83%) for maintenance operations
- Increased components lifetime
- Possibility to upgrade also for previous generation heads

INTELLIVALVE TECHNOLOGY

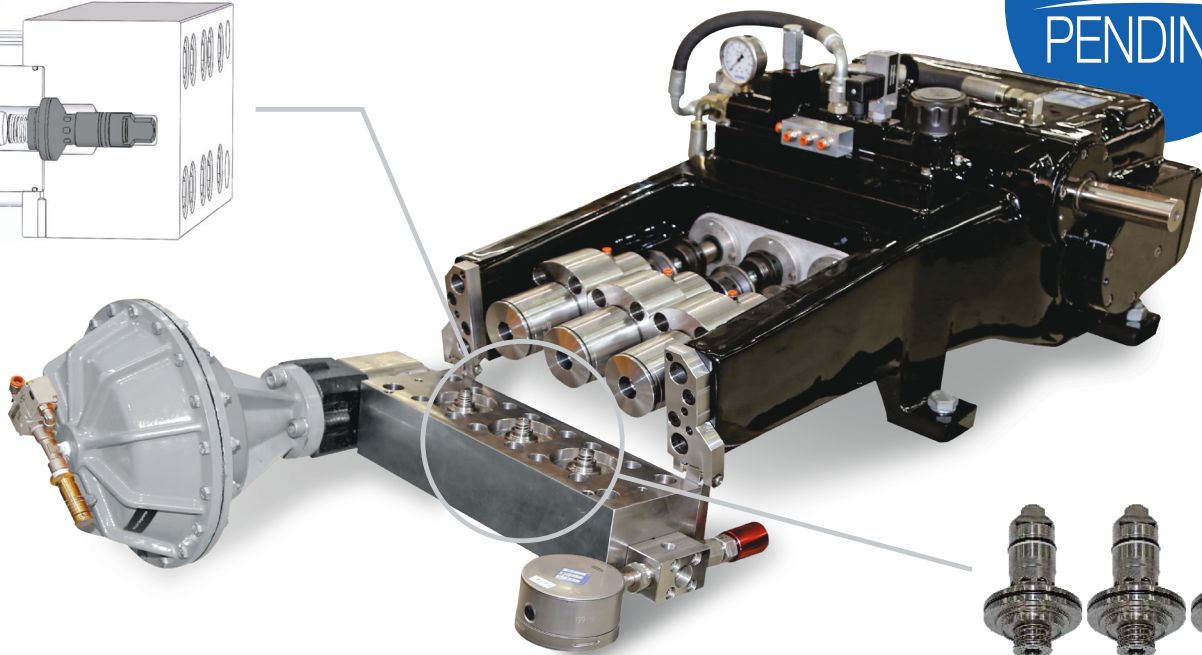
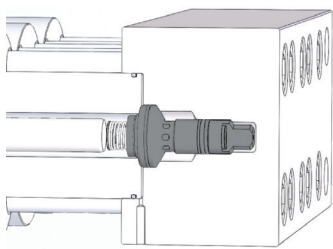

**PATENT
PENDING**



3 PIECES FOR PUMP

BENEFITS



Fewer pieces



Maximum pressure
40.000 psi
(2800 bar)



Longer useful life
of components



Flow rate up
to 38 USgpm
(145 l/min)



Easy to
assemble



Independent
operation



Quick and easy
maintenance in
15 minutes

PERFORMANCES

LEGEND

 With tungsten carbide plunger

 With forced lubrication

 Heat exchanger





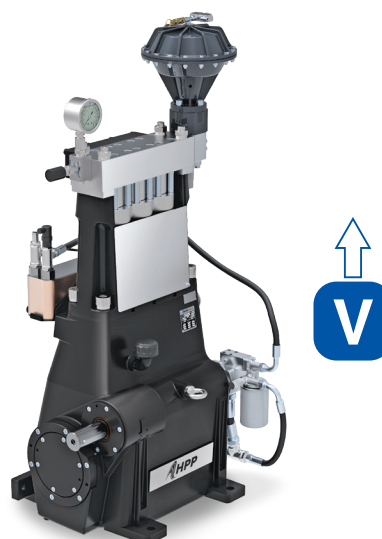
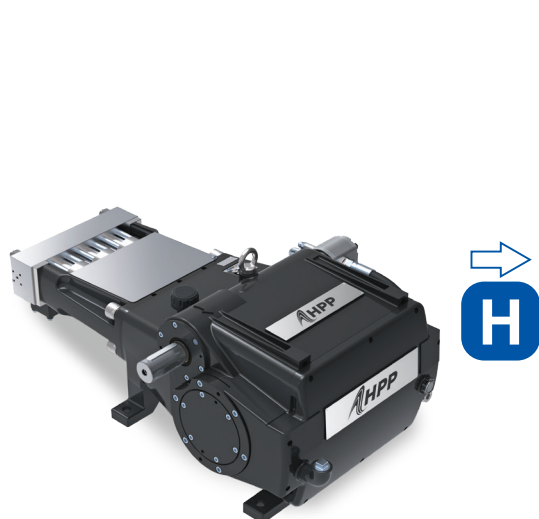

 **V** Vertical assembling

 **H** Horizontal assembling



SAP SERIES UP TO 1500 BAR

 H-100 SAP  

 IV GENERATION		Motor Engine		Crankshaft									
Code	Ø mm	rpm	gear ratio	rpm	l/min	USgpm	bar	psi	MPa	HP	kW	kg	lb
P231152H14180	18	1500	2,9	517	31,6	8,3	1400	20300	140	111,3	81,9	400	882
P231162H14180		1800	3,6	502	30,6	8,1	1400	20300	140	107,9	79,4	400	882
P231152H14200	20	1500	2,9	517	39,0	10,3	1000	14500	100	98,1	72,2	400	882
P231162H14200		1800	3,6	502	37,8	10,0	1000	14500	100	95,2	70,0	400	882
P231152H14220	22	1500	2,9	517	47,2	12,5	900	13050	90	106,9	78,6	400	882
P231162H14220		1800	3,6	502	45,7	12,1	900	13050	90	103,6	76,2	400	882
P231152H14240	24	1500	2,9	517	56,1	14,8	750	10875	75	106,0	78,0	400	882
P231162H14240		1800	3,6	502	54,4	14,4	750	10875	75	102,8	75,6	400	882
P231152H14260	26	1500	2,9	517	65,9	17,4	650	9425	65	107,8	79,3	400	882
P231162H14260		1800	3,6	502	63,9	16,9	650	9425	65	104,5	76,9	400	882
P231152H14280	28	1500	2,9	517	76,4	20,2	600	8700	60	115,4	84,9	400	882
P231162H14280		1800	3,6	502	74,1	19,6	600	8700	60	111,9	82,3	400	882
P231152H14300	30	1500	2,9	517	87,7	23,2	500	7250	50	110,4	81,2	400	882
P231162H14300		1800	3,6	502	85,1	22,5	500	7250	50	107,1	78,8	400	882
P231152H14320	32	1500	2,9	517	99,8	26,4	420	6090	42	105,5	77,6	400	882
P231162H14320		1800	3,6	502	96,8	25,6	420	6090	42	102,3	75,3	400	882
P231152H14350	35	1500	2,9	517	119,4	31,5	330	4785	33	99,2	73,0	400	882
P231162H14350		1800	3,6	502	115,8	30,6	330	4785	33	96,2	70,7	400	882
P231152H14400	40	1500	2,9	517	155,9	41,2	270	3915	27	106,0	78,0	400	882
P231162H14400		1800	3,6	502	151,2	39,9	270	3915	27	102,8	75,6	400	882

Performances refer to theoretical delivery with 100% volumetric efficiency. For continuous or heavy-duty use, contact our technical department.

H-150 SAP

IV GENERATION	IV GENERATION				Crankshaft									
Code	Code	Ø mm	rpm	gear ratio	rpm	l/min	USgpm	bar	psi	MPa	HP	kW	kg	lb
P231552V14220	P231552H14220	22	1500	2,9	517	47,2	12,5	1400	20300	140	166,3	122,3	400	882
P231562V14220	P231562H14220		1800	3,6	502	45,7	12,1	1400	20300	140	161,2	118,6	400	882
P231552V14240	P231552H14240	24	1500	2,9	517	56,1	14,8	1200	17400	120	169,6	124,7	400	882
P231562V14240	P231562H14240		1800	3,6	502	54,4	14,4	1200	17400	120	164,5	121,0	400	882
P231552V14260	P231552H14260	26	1500	2,9	517	65,9	17,4	1000	14500	100	165,9	122,0	400	882
P231562V14260	P231562H14260		1800	3,6	502	63,9	16,9	1000	14500	100	160,8	118,3	400	882
P231552V14280	P231552H14280	28	1500	2,9	517	76,4	20,2	830	12035	83	159,7	117,4	400	882
P231562V14280	P231562H14280		1800	3,6	502	74,1	19,6	830	12035	83	154,8	113,9	400	882
P231552V14300	P231552H14300	30	1500	2,9	517	87,7	23,2	750	10875	75	165,6	121,8	400	882
P231562V14300	P231562H14300		1800	3,6	502	85,1	22,5	750	10875	75	160,6	118,1	400	882
P231552V14320	P231552H14320	32	1500	2,9	517	99,8	26,4	640	9280	64	160,8	118,3	400	882
P231562V14320	P231562H14320		1800	3,6	502	96,8	25,6	640	9280	64	155,9	114,7	400	882
P231552V14350	P231552H14350	35	1500	2,9	517	119,4	31,5	560	8120	56	168,3	123,8	400	882
P231562V14350	P231562H14350		1800	3,6	502	115,8	30,6	560	8120	56	163,2	120,1	400	882
P231552V14400	P231552H14400	40	1500	2,9	517	155,9	41,2	400	5800	40	157,0	115,5	400	882
P231562V14400	P231562H14400		1800	3,6	502	151,2	39,9	400	5800	40	152,3	112,0	400	882







Performances refer to theoretical delivery with 100% volumetric efficiency. For continuous or heavy-duty use, contact our technical department.

H-200 SAP

IV GENERATION	IV GENERATION				Crankshaft									
Code	Code	Ø mm	rpm	gear ratio	rpm	l/min	USgpm	bar	psi	MPa	HP	kW	kg	lb
P232052V14220	P232052H14220	22	1500	3,14	478	54,5	14,4	1470	21315	147	201,8	148,4	500	1103
P232062V14220	P232062H14220		1800	3,79	475	54,1	14,3	1470	21315	147	200,4	147,4	500	1103
P232052V14240	P232052H14240	24	1500	3,14	478	64,9	17,1	1300	18850	130	212,4	156,2	500	1103
P232062V14240	P232062H14240		1800	3,79	475	64,4	17,0	1300	18850	130	210,9	155,1	500	1103
P232052V14260	P232052H14260	26	1500	3,14	478	76,1	20,1	1200	17400	120	230,1	169,2	500	1103
P232062V14260	P232062H14260		1800	3,79	475	75,6	20,0	1200	17400	120	228,5	168,0	500	1103
P232052V14280	P232052H14280	28	1500	3,14	478	88,3	23,3	1000	14500	100	222,3	163,5	500	1103
P232062V14280	P232062H14280		1800	3,79	475	87,7	23,2	1000	14500	100	220,8	162,4	500	1103
P232052V14300	P232052H14300	30	1500	3,14	478	101,4	26,8	800	11600	80	204,2	150,2	500	1103
P232062V14300	P232062H14300		1800	3,79	475	100,7	26,6	800	11600	80	202,8	149,2	500	1103
P232052V14320	P232052H14320	32	1500	3,14	478	115,3	30,5	700	10150	70	203,3	149,5	500	1103
P232062V14320	P232062H14320		1800	3,79	475	114,5	30,3	700	10150	70	201,9	148,5	500	1103
P232052V14350	P232052H14350	35	1500	3,14	478	138,0	36,5	600	8700	60	208,5	153,3	500	1103
P232062V14350	P232062H14350		1800	3,79	475	137,0	36,2	600	8700	60	207,0	152,3	500	1103
P232052V14400	P232052H14400	40	1500	3,14	478	180,2	47,6	450	6525	45	204,2	150,2	500	1103
P232062V14400	P232062H14400		1800	3,79	475	179,0	47,3	450	6525	45	202,8	149,2	500	1103







Performances refer to theoretical delivery with 100% volumetric efficiency. For continuous or heavy-duty use, contact our technical department.

H-300 SAP

 IV GENERATION	 IV GENERATION	 Motor Engine	 Crankshaft											
Code	Code	Ø mm	rpm	gear ratio	rpm	l/min	USgpm	bar	psi	MPa	HP	kW	kg	lb
P233152V14300	P233152H14300	30	1500	3,13	480	99,7	26,3	1400	20300	140	351,4	258,5	700	1544
P233162V14300	P233162H14300		1800	3,67	491	102,0	26,9	1400	20300	140	359,5	264,4	700	1544
P233152V14320	P233152H14320	32	1500	3,13	480	113,4	30,0	1200	17400	120	342,7	252,1	700	1544
P233162V14320	P233162H14320		1800	3,67	491	116,0	30,7	1200	17400	120	350,6	257,9	700	1544
P233152V14350	P233152H14350	35	1500	3,13	480	135,7	35,8	1000	14500	100	341,7	251,3	700	1544
P233162V14350	P233162H14350		1800	3,67	491	138,8	36,7	1000	14500	100	349,5	257,1	700	1544
P233152V14400	P233152H14400	40	1500	3,13	480	177,2	46,8	750	10875	75	334,7	246,2	700	1544
P233162V14400	P233162H14400		1800	3,67	491	181,3	47,9	750	10875	75	342,4	251,8	700	1544

Performances refer to theoretical delivery with 100% volumetric efficiency. For continuous or heavy-duty use, contact our technical department.







H-550 SAP

 IV GENERATION	 Motor Engine	 Crankshaft											
Code	Ø mm	rpm	gear ratio	rpm	l/min	USgpm	bar	psi	MPa	HP	kW	kg	lb
P235562H14400	40	1800	4	450	176,3	46,6	1250	18125	125	555,0	408,2	1500	3307
P235562H14450	45	1800	4	450	223,2	59,0	1000	14500	100	561,9	413,3	1500	3307

Performances refer to theoretical delivery with 100% volumetric efficiency. For continuous or heavy-duty use, contact our technical department.

UAP SERIES UP TO 2800 BAR

H-100 UAP

 IV GENERATION	 Motor Engine	 Crankshaft											
Code	Ø mm	rpm	gear ratio	rpm	l/min	USgpm	bar	psi	MPa	HP	kW	kg	lb
P231153H14120	12	1500	2,9	517	12,6	3,3	2800	40600	280	89,0	65,5	400	882
P231163H14120		1800	3,6	502	12,2	3,2	2800	40600	280	86,3	63,5	400	882
P231153H14140	14	1500	2,9	517	17,2	4,5	2500	36250	250	108,2	79,6	400	882
P231163H14140		1800	3,6	502	16,7	4,4	2500	36250	250	104,9	77,2	400	882
P231153H14160	16	1500	2,9	517	22,5	5,9	2000	29000	200	113,1	83,2	400	882
P231163H14160		1800	3,6	502	21,8	5,8	2000	29000	200	109,6	80,6	400	882
P231153H14180	18	1500	2,9	517	28,4	7,5	1400	20300	140	100,2	73,7	400	882
P231163H14180		1800	3,6	502	27,6	7,3	1400	20300	140	97,1	71,4	400	882
P231153H14200	20	1500	2,9	517	35,1	9,3	1000	14500	100	88,3	65,0	400	882
P231163H14200		1800	3,6	502	34,0	9,0	1000	14500	100	85,7	63,0	400	882

Performances refer to theoretical delivery with 100% volumetric efficiency. For continuous or heavy-duty use, contact our technical department.

H-150 UAP

IV GENERATION	IV GENERATION		Motor Engine	Crankshaft										
Code	Code	Ø mm	rpm	gear ratio	rpm	l/min	USgpm	bar	psi	MPa	HP	kW	kg	lb
P231553V14160	P231553H14160	16	1500	2,9	517	22,5	5,9	2800	40600	280	158,3	116,4	400	882
P231563V14160	P231563H14160		1800	3,6	502	21,8	5,8	2800	40600	280	153,5	112,9	400	882
P231553V14180	P231553H14180	18	1500	2,9	517	28,4	7,5	2200	31900	220	157,4	115,8	400	882
P231563V14180	P231563H14180		1800	3,6	502	27,6	7,3	2200	31900	220	152,6	112,3	400	882
P231553V14200	P231553H14200	20	1500	2,9	517	35,1	9,3	1800	26100	180	159,0	116,9	400	882
P231563V14200	P231563H14200		1800	3,6	502	34,0	9,0	1800	26100	180	154,2	113,4	400	882

Performances refer to theoretical delivery with 100% volumetric efficiency. For continuous or heavy-duty use, contact our technical department.

H-200 UAP

IV GENERATION	IV GENERATION		Motor Engine	Crankshaft										
Code	Code	Ø mm	rpm	gear ratio	rpm	l/min	USgpm	bar	psi	MPa	HP	kW	kg	lb
P232053V14160	P232053H14160	16	1500	3,14	478	26,0	6,9	2800	40600	280	183,0	134,6	500	1103
P232063V14160	P232063H14160		1800	3,79	475	25,8	6,8	2800	40600	280	181,7	133,6	500	1103
P232053V14180	P232053H14180	18	1500	3,14	478	32,8	8,7	2500	36250	250	206,7	152,1	500	1103
P232063V14180	P232063H14180		1800	3,79	475	32,6	8,6	2500	36250	250	205,3	151,0	500	1103
P232053V14200	P232053H14200	20	1500	3,14	478	40,6	10,7	2000	29000	200	204,2	150,2	500	1103
P232063V14200	P232063H14200		1800	3,79	475	40,3	10,6	2000	29000	200	202,8	149,2	500	1103

Performances refer to theoretical delivery with 100% volumetric efficiency. For continuous or heavy-duty use, contact our technical department.







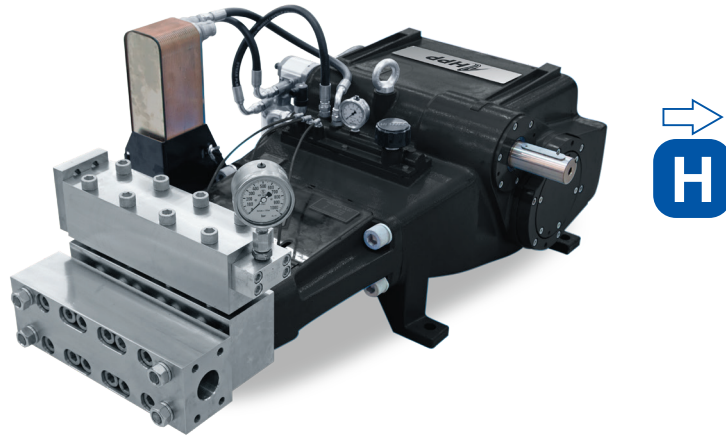

H-300 UAP

IV GENERATION	IV GENERATION		Motor Engine	Crankshaft										
Code	Code	Ø mm	rpm	gear ratio	rpm	l/min	USgpm	bar	psi	MPa	HP	kW	kg	lb
P233153V14200	P233153H14200	20	1500	3,13	480	39,9	10,5	2800	40600	280	281,2	206,8	700	1544
P233163V14200	P233163H14200		1800	3,67	491	40,8	10,8	2800	40600	280	287,6	211,5	700	1544

Performances refer to theoretical delivery with 100% volumetric efficiency. For continuous or heavy-duty use, contact our technical department.



H-100 SAP L  

													
Code	Ø mm	rpm	gear ratio	rpm	l/min	USgpm	bar	psi	MPa	HP	kW	kg	lb
P231154H11400	40	1500	2,9	517	155,9	41,2	270	3915	27	106,0	78,0	400	882
P231164H11400		1800	3,6	502	151,2	39,9	270	3915	27	102,8	75,6	400	882
P231154H11450	45	1500	2,9	517	197,3	52,1	215	3117,5	21,5	106,8	78,6	400	882
P231164H11450		1800	3,6	502	191,4	50,6	215	3117,5	21,5	103,6	76,2	400	882
P231154H11500	50	1500	2,9	517	243,6	64,4	170	2465	17	104,3	76,7	400	882
P231164H11500		1800	3,6	502	236,3	62,4	170	2465	17	101,1	74,4	400	882
P231154H11550	55	1500	2,9	517	294,8	77,9	145	2102,5	14,5	107,6	79,2	400	882
P231164H11550		1800	3,6	502	285,9	75,5	145	2102,5	14,5	104,4	76,8	400	882
P231154H11650	65	1500	2,9	517	411,9	108,8	110	1595,4	11	114,0	85,0	400	882
P231164H11650		1800	3,6	500	398,2	105,2	110	1595,4	11	110,2	82,2	400	882

Performances refer to theoretical delivery with 100% volumetric efficiency. For continuous or heavy-duty use, contact our technical department.

H-150 SAP L

Code	Code	Ø mm	rpm	gear ratio	rpm	l/min	USgpm	bar	psi	MPa	HP	kW	kg	lb
P231554V11400	P231554H11400	40	1500	2,9	517	155,9	41,2	400	5800	40	157,0	115,5	400	882
P231564V11400	P231564H11400		1800	3,6	502	151,2	39,9	400	5800	40	152,3	112,0	400	882
P231554V11450	P231554H11450	45	1500	2,9	517	197,3	52,1	320	4640	32	159,0	116,9	400	882
P231564V11450	P231564H11450		1800	3,6	502	191,4	50,6	320	4640	32	154,2	113,4	400	882
P231554V11500	P231554H11500	50	1500	2,9	517	243,6	64,4	260	3770	26	159,5	117,3	400	882
P231564V11500	P231564H11500		1800	3,6	502	236,3	62,4	260	3770	26	154,7	113,8	400	882
P231554V11550	P231554H11550	55	1500	2,9	517	294,8	77,9	215	3117,5	21,5	159,6	117,4	400	882
P231564V11550	P231564H11550		1800	3,6	502	285,9	75,5	215	3117,5	21,5	154,7	113,8	400	882
P231554V11650	P231554H11650	65	1500	2,9	517	411,9	108,8	160	2320,6	16	165,8	123,7	400	882
P231564V11650	P231564H11650		1800	3,6	500	398,2	105,2	160	2320,6	16	160,3	119,5	400	882









Performances refer to theoretical delivery with 100% volumetric efficiency. For continuous or heavy-duty use, contact our technical department.

H-200 SAP L

Code	Code	Ø mm	rpm	gear ratio	rpm	l/min	USgpm	bar	psi	MPa	HP	kW	kg	lb
P232054V11400	P232054H11400	40	1500	3,14	478	180,2	47,6	450	6525	45	204,2	150,2	500	1103
P232064V11400	P232064H11400		1800	3,79	475	179,0	47,3	450	6525	45	202,8	149,2	500	1103
P232054V11450	P232054H11450	45	1500	3,14	478	228,1	60,3	355	5147,5	35,5	203,9	150,0	500	1103
P232064V11450	P232064H11450		1800	3,79	475	226,5	59,8	355	5147,5	35,5	202,5	148,9	500	1103
P232054V11500	P232054H11500	50	1500	3,14	478	281,6	74,4	290	4205	29	205,6	151,2	500	1103
P232064V11500	P232064H11500		1800	3,79	475	279,7	73,9	290	4205	29	204,2	150,2	500	1103
P232054V11550	P232054H11550	55	1500	3,14	478	340,7	90,0	240	3480	24	205,9	151,4	500	1103
P232064V11550	P232064H11550		1800	3,79	475	338,4	89,4	240	3480	24	204,5	150,4	500	1103
P232054V11650	P232054H11650	65	1500	3,14	478	380,4	100,5	180	2610,72	18	172,3	128,5	500	1103
P232064V11650	P232064H11650		1800	3,79	475	378,2	99,9	180	2610,72	18	171,3	127,7	500	1103

Performances refer to theoretical delivery with 100% volumetric efficiency. For continuous or heavy-duty use, contact our technical department.







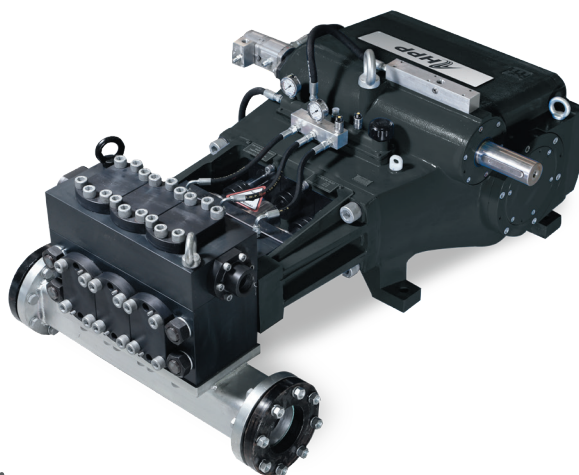

H-300 SAP L

														
Code	Code	Ø mm	rpm	gear ratio	rpm	l/min	USgpm	bar	psi	MPa	HP	kW	kg	lb
P233154V11400	P233154H11400	40	1500	3,13	480	177,2	46,8	750	10875	75	334,7	246,2	700	1544
P233164V11400	P233164H11400		1800	3,67	491	181,3	47,9	750	10875	75	342,4	251,8	700	1544
P233154V11450	P233154H11450	45	1500	3,13	480	224,3	59,3	600	8700	60	338,9	249,3	700	1544
P233164V11450	P233164H11450		1800	3,67	491	229,5	60,6	600	8700	60	346,7	255,0	700	1544
P233154V11500	P233154H11500	50	1500	3,13	480	276,9	73,2	490	7105	49	341,7	251,3	700	1544
P233164V11500	P233164H11500		1800	3,67	491	283,3	74,8	490	7105	49	349,5	257,1	700	1544
P233154V11550	P233154H11550	55	1500	3,13	480	335,1	88,5	400	5800	40	337,5	248,2	700	1544
P233164V11550	P233164H11550		1800	3,67	491	342,8	90,6	400	5800	40	345,2	253,9	700	1544
P233154V11650	P233154H11650	65	1500	3,13	479	381,7	100,8	300	4351,2	30	288,1	214,8	700	1544
P233164V11650	P233164H11650		1800	3,67	490	390,6	103,2	300	4351,2	30	294,8	219,9	700	1544

Performances refer to theoretical delivery with 100% volumetric efficiency. For continuous or heavy-duty use, contact our technical department.



H-550 SAP L

													
Code	Ø mm	rpm	gear ratio	rpm	l/min	USgpm	bar	psi	MPa	HP	kW	kg	lb
P235564H11820	82	1800	4	450	741,1	195,8	320	4640	32	597,1	439,2	1500	3307
P235564H111020	102	1800	4	450	1146,7	302,9	200	2900	20	577,4	424,7	1500	3307

Performances refer to theoretical delivery with 100% volumetric efficiency. For continuous or heavy-duty use, contact our technical department.

SAP & UAP PUMPS DIMENSIONS

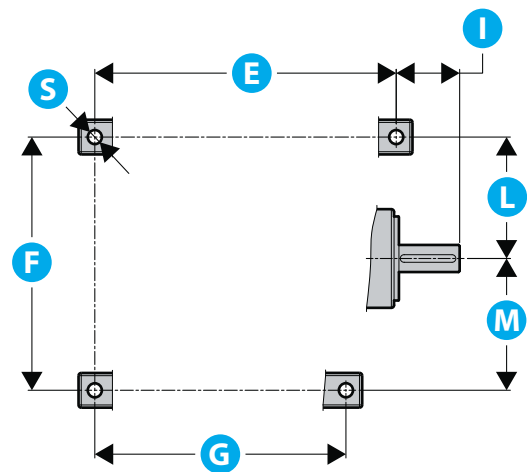
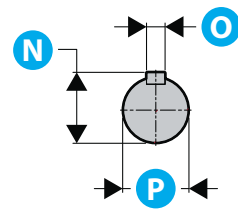
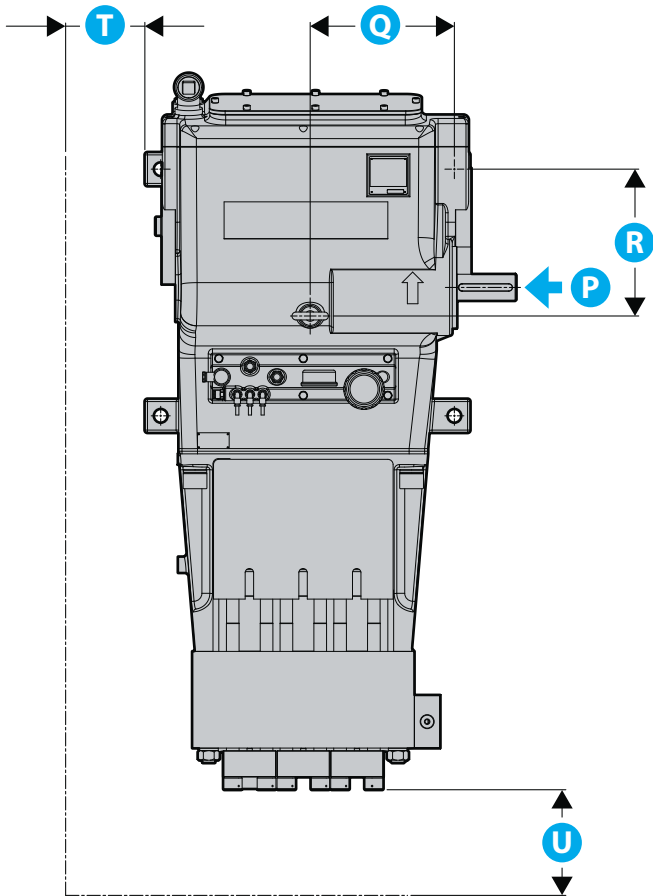
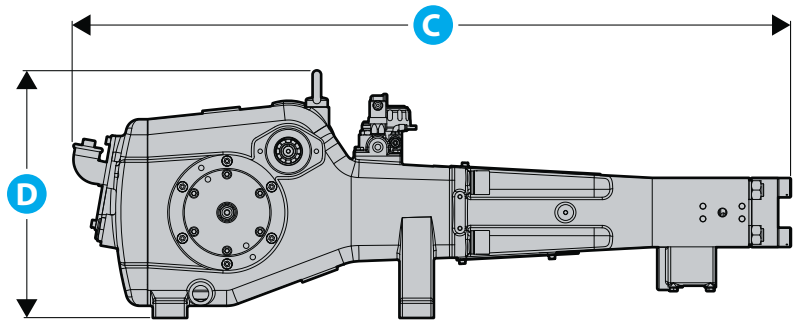
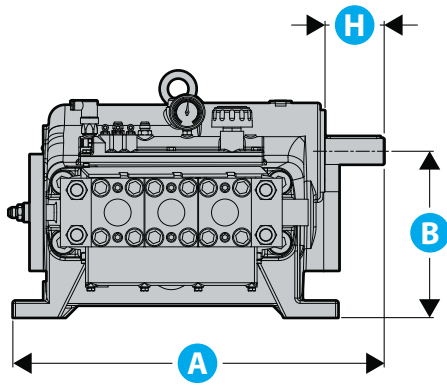

Pump Model		H-100 SAP	H-150 SAP	H-200 SAP	H-300 SAP	H-550 SAP	H-100 UAP	H-150 UAP	H-200 UAP	H-300 UAP
A	mm	699,5	699,5	703	739	1004	699,5	699,5	703	739
	(in)	(27,54)	(27,54)	(27,68)	(29,09)	(39,53)	(27,54)	(27,54)	(27,68)	(29,09)
B	mm	265	265	315	355	450	265	265	315	355
	(in)	(10,43)	(10,43)	(12,40)	(13,98)	(17,72)	(10,43)	(10,43)	(12,40)	(13,98)
C	mm	1150	1150	1263	1292	1650	1150	1150	1262	1293
	(in)	(45,27)	(45,27)	(49,72)	(50,86)	(64,96)	(45,27)	(45,27)	(49,68)	(50,90)
D	mm	407,5	407,5	467,5	505	699	407,5	407,5	467,5	505
	(in)	(16,04)	(16,04)	(18,41)	(19,88)	(27,52)	(16,04)	(16,04)	(18,41)	(19,88)
E	mm	565	565	556	592	813	565	565	556	592
	(in)	(22,24)	(22,24)	(21,89)	(23,31)	(32,01)	(22,24)	(22,24)	(21,89)	(23,31)
F	mm	390	390	467	540	610	390	390	467	540
	(in)	(15,35)	(15,35)	(18,39)	(21,26)	(24,02)	(15,35)	(15,35)	(18,39)	(21,26)
G	mm	545	545	556	553	720	545	545	556	553
	(in)	(21,45)	(21,45)	(21,89)	(21,77)	(28,35)	(21,46)	(21,46)	(21,89)	(21,77)
H	mm	120,5	120,5	112	126,5	182	120,5	120,5	112	126,5
	(in)	(4,74)	(4,74)	(4,41)	(4,98)	(7,17)	(4,74)	(4,74)	(4,41)	(4,98)
I	mm	109,5	109,5	117	117	158,5	109,5	109,5	117	117
	(in)	(4,31)	(4,31)	(4,61)	(4,61)	(6,24)	(4,31)	(4,31)	(4,61)	(4,61)
L	mm	190	190	224	286,4	343,5	190	190	224	286,4
	(in)	(7,48)	(7,48)	(8,82)	(11,28)	(13,5)	(7,48)	(7,48)	(8,82)	(11,28)
M	mm	200	200	243	253,6	266,5	200	200	243	253,6
	(in)	(7,87)	(7,87)	(9,57)	(9,98)	(10,49)	(7,87)	(7,87)	(9,57)	(9,98)
N	mm	43	43	53,5	62	79,5	43	43	53,5	62
	(in)	(1,69)	(1,69)	(2,11)	(2,44)	(3,13)	(1,69)	(1,69)	(2,11)	(2,44)
O	mm	12 (DIN 6885)	12 (DIN 6885)	14 (DIN 6885)	16 (DIN 6885)	20 (DIN 6885)	12 (DIN 6885)	12 (DIN 6885)	14 (DIN 6885)	16 (DIN 6885)
	(in)	(0,47)	(0,47)	(0,55)	(0,63)	(0,79)	(0,47)	(0,47)	(0,55)	(0,63)
P	mm	ø 40 +0,018 +0,002	ø 40 +0,018 +0,002	ø 50 +0,018 +0,002	ø 58 +0,021 +0,002	ø 75 +0,021 +0,002	ø 40 +0,018 +0,002	ø 40 +0,018 +0,002	ø 50 +0,018 +0,002	ø 58 +0,021 +0,002
	(in)	(ø 1,57)	(ø 1,57)	(ø 1,97)	(ø 2,28)	(ø 2,95)	(ø 1,57)	(ø 1,57)	(ø 1,97)	(ø 2,28)
Q	mm	272,5	272,5	273	320	401,5	272,5	272,5	273	320
	(in)	(10,73)	(10,73)	(10,75)	(12,60)	(15,79)	(10,73)	(10,73)	(10,75)	(12,60)
R	mm	231	231	278	340	426	231	231	278	340
	(in)	(9,09)	(9,09)	(10,94)	(13,39)	(16,77)	(9,09)	(9,09)	(10,94)	(13,39)
S	mm	ø 26	ø 26	ø 26	ø 26	ø 28	ø 26	ø 26	ø 26	ø 26
	(in)	(ø 1,02)	(ø 1,02)	(ø 1,02)	(ø 1,02)	(1,10)	(ø 1,02)	(ø 1,02)	(ø 1,02)	(ø 1,02)
T	mm	150	150	150	150	150	150	150	150	150
	(in)	(5,91)	(5,91)	(5,91)	(5,91)	(5,91)	(5,91)	(5,91)	(5,91)	(5,91)
U	mm	500	500	500	500	500	500	500	500	500
	(in)	(19,69)	(19,69)	(19,69)	(19,69)	(19,69)	(19,69)	(19,69)	(19,69)	(19,69)

SAP L PUMPS DIMENSIONS

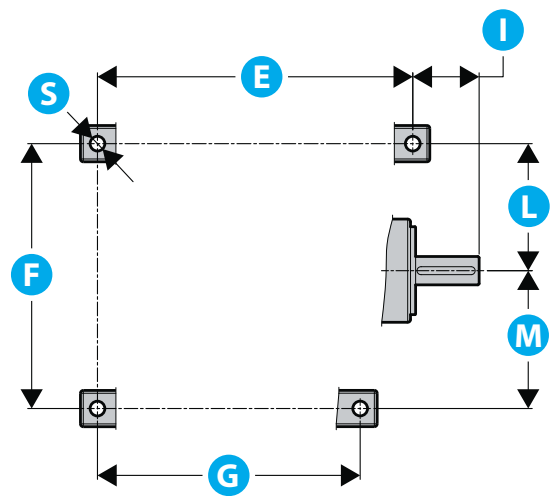
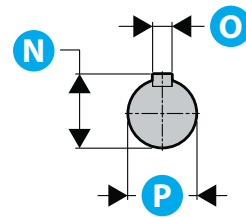
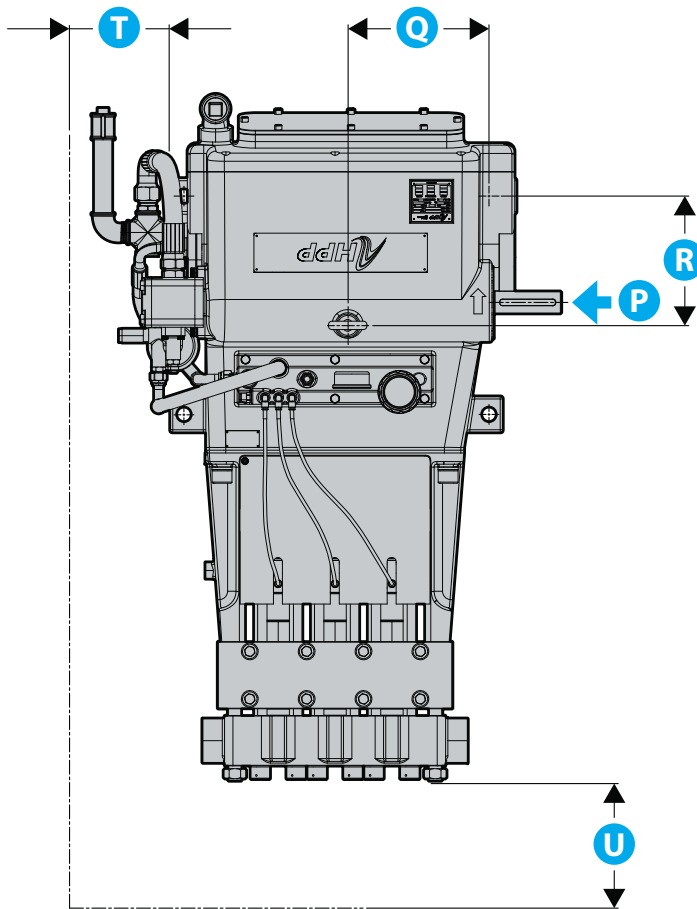
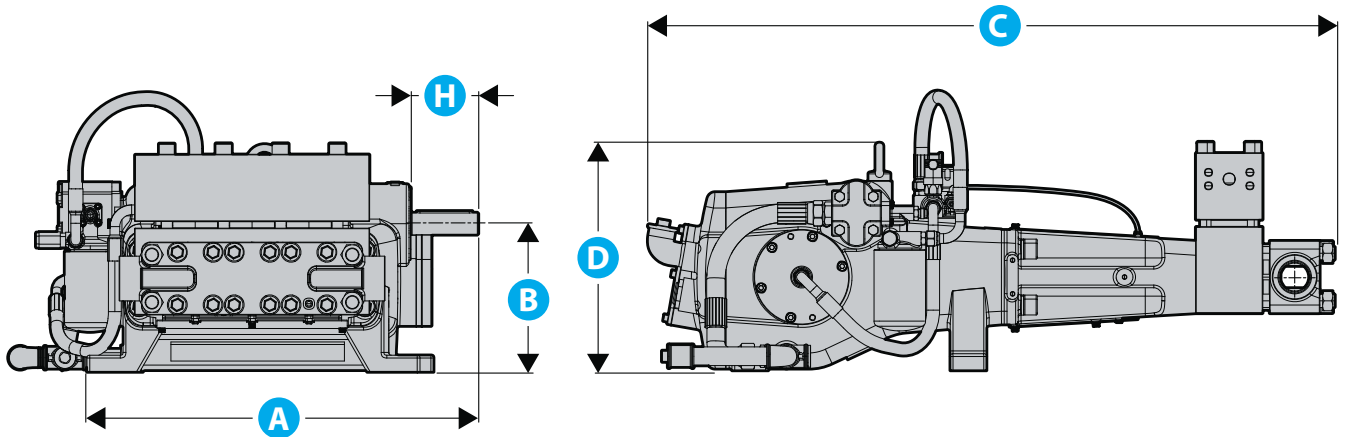

Pump Model		H-100 SAP L	H-150 SAP L	H-200 SAP L	H-300 SAP L	H-550 SAP L
A	mm	699,5	699,5	703	739	1004
	(in)	(27,54)	(27,54)	(27,68)	(29,09)	(39,52)
B	mm	265	265	315	355	450
	(in)	(10,43)	(10,43)	(12,40)	(13,98)	(17,72)
C	mm	1220	1220	1335	1364	1725
	(in)	(48,03)	(48,03)	(52,55)	(53,70)	(67,91)
D	mm	407,5	407,5	467,5	505	669
	(in)	(16,04)	(16,04)	(18,41)	(19,88)	(26,33)
E	mm	565	565	556	592	813
	(in)	(22,24)	(22,24)	(21,89)	(23,31)	(32,01)
F	mm	390	390	467	540	610
	(in)	(15,35)	(15,35)	(18,39)	(21,26)	(24,02)
G	mm	545	545	556	553	720
	(in)	(21,45)	(21,45)	(21,89)	(21,77)	(28,35)
H	mm	120,5	120,5	112	126,5	182
	(in)	(4,74)	(4,74)	(4,41)	(4,98)	(7,17)
I	mm	109,5	109,5	117	117	158,5
	(in)	(4,31)	(4,31)	(4,61)	(4,61)	(6,24)
L	mm	190	190	224	286,4	343,5
	(in)	(7,48)	(7,48)	(8,82)	(11,28)	(13,5)
M	mm	200	200	243	253,6	266,5
	(in)	(7,87)	(7,87)	(9,57)	(9,98)	(10,49)
N	mm	43	43	53,5	62	79,5
	(in)	(1,69)	(1,69)	(2,11)	(2,44)	(3,13)
O	mm	12 (DIN 6885)	12 (DIN 6885)	14 (DIN 6885)	16 (DIN 6885)	20 (DIN 6885)
	(in)	(0,47)	(0,47)	(0,55)	(0,63)	(0,79)
P	mm	ø 40 +0,018 +0,002	ø 40 +0,018 +0,002	ø 50 +0,018 +0,002	ø 58 +0,021 +0,002	ø 75 +0,021 +0,002
	(in)	(ø 1,57)	(ø 1,57)	(ø 1,97)	(ø 2,28)	(ø 2,95)
Q	mm	272,5	272,5	273	320	401,5
	(in)	(10,73)	(10,73)	(10,75)	(12,60)	(15,79)
R	mm	231	231	278	340	426
	(in)	(9,09)	(9,09)	(10,94)	(13,39)	(16,77)
S	mm	ø 26	ø 26	ø 26	ø 26	ø 28
	(in)	(ø 1,02)	(ø 1,02)	(ø 1,02)	(ø 1,02)	(1,10)
T	mm	150	150	150	150	150
	(in)	(5,91)	(5,91)	(5,91)	(5,91)	(5,91)
U	mm	500	500	500	500	500
	(in)	(19,69)	(19,69)	(19,69)	(19,69)	(19,69)

SCIMITAR 22K - 40K

Scimitar are fundamental tools for waterblasting featuring an efficient speed control system, adjustable thanks to a magnetic brake with easy-rotation of the handle grip. Specially developed for surface treatment, they can be mounted on gun lance or automatized systems.

These lightweight tools are particularly efficient for surface preparation. Scimitar are easy-to-use and easy-to-maintain tools, suitable for many different working areas.

SELF-ROTARY WATERBLASTING TOOLS



PUMP ACCESSORIES

REGULATING VALVES



PNEUMATIC CONTROL VALVES



SAFETY VALVES



PRESSURE GAUGES



ACCESSORIES FOR WORK

DUMP SHUT GUNS / UNDERWATER GUNS / PNEUMATIC GUNS



DUMP TYPE FOOT VALVE

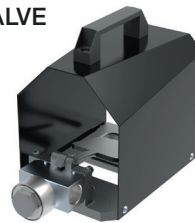

MULTI-JET

Multi-purpose surface. Preparation system for floors and hulls. 2800 bar (40K psi).



POWER BOX

3/2" Ultra High Pressure control valve to control the gun's water flow and/or operate with a multi-gun system.

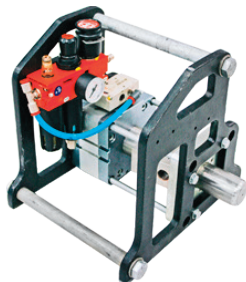

HIGH PRESSURE HOSES ULTRA HIGH PRESSURE HOSES



FLEXIBLE LANCE NOZZLES RIGID LANCE NOZZLES



HIGH PRESSURE SWIVEL FOR HOSES



ROTATING NOZZLES



PROTECTIVE CLOTHING FOR WATERJETTING (TST)





FLEXIBLE LANCES / RIGID LANCES



HIGH PRESSURE PUMPS FOR AN ENTIRE WORLD OF POSSIBLE APPLICATIONS

Application	Bar (Psi)	
<p>ALLUMINIUM AND STEEL MILLS Hardened bauxite dust on mills, filters, floors, tanks, sumps and sewers; water scale, coke, ore and lime in heat exchangers, flues, boilers, open hearths, furnaces, chutes and hoppers, descaling billets and water hydraulics; mill scale, tight rust and weld slag from vessels, tanks and pipes.</p>	<p>200 - 2.800 (3.000 - 40.000)</p>	

Application	Bar (Psi)	
 <p>AUTOMOTIVE Paint from booths, machinery, gratings, conveyers, dollies and skids.</p>	<p>700 - 2.800 (10.000 - 40.000)</p>	

Application	Bar (Psi)	
<p>AVIATION Expansion joints, grease, rubber and hydraulic fluids on airport runways.</p>	<p>700 - 1.400 (10.000 - 20.000)</p>	

Application	Bar (Psi)	
 <p>BREWERIES AND DISTILLERIES Yeast, sediments and fermentation residues on vats, pipes and facilities; cleaning of boilers tubes, vats and pipe lines.</p>	<p>200 - 1.500 (3.000 - 22.000)</p>	

HIGH PRESSURE PUMPS FOR AN ENTIRE WORLD OF POSSIBLE APPLICATIONS

Application	Bar (Psi)
<p>CEMENT PLANTS external piping, bins, walls, hopper cars and handling equipment; cooler hearths and pre-heater columns, bins, hopper cars, floors, rotary kilns and walls.</p>	<p>200 - 1.000 (3.000 - 15.000)</p>



Application	Bar (Psi)
<p>CHEMICAL PROCESSING Chemicals from boiler tubes, tanks, valves, evaporators, heat exchangers, tube bundles, pipes, vessels, reactors and facilities.</p>	<p>350 - 2.800 (5.000 - 40.000)</p>

Application	Bar (Psi)
<p>CONSTRUCTION AND RENOVATION Asphalt distributors, mixers, tar cookers and pavers; asphalt, dirt, concrete, mortar, tar, grease, mastic and clay on vehicles, mixer trucks and machinery; canals, lifts, dams and runways; cleaning of natural stone walling, removal of joint materials, coats, damaged or corroded coatings from walls and floors, roughening of concrete and stone surfaces.</p>	<p>200 - 2.800 (3.000 - 40.000)</p>





Application	Bar (Psi)
<p>FOOD AND BEVERAGES PROCESSING Fats, oils, dirt and dough, food residues from vats, ovens, mixers, conveyors and facilities; cleaning of cold storage facilities, slaughter-houses, fish and meat butchers, sugar processing plants, bottling plants, food cutting, evaporators, milk tanks, centralised dairy systems, ultra-filtration by reverse osmosis; water jet cutting.</p>	<p>200 - 1.000 (3.000 - 15.000)</p>

HIGH PRESSURE PUMPS FOR AN ENTIRE WORLD OF POSSIBLE APPLICATIONS

Application	Bar (Psi)	
<p>FOUNDRIES Removal of deposits, metal oxidation, ceramic and sand core materials from castings, furnaces and paddles.</p>	<p>100 - 700 (1.500 - 10.000)</p>	

Application	Bar (Psi)	Bar (Psi)
 <p>HYDRODEMOLITION Concrete cement cutting, reclamation and wet sandblasting of tunnels also using special robots; concrete surface hydro-ripping for large infrastructure, dams, viaducts, homes and offices; surface preparation.</p>		<p>1.000 - 2.800 (15.000 - 40.000)</p>

Application	Bar (Psi)	
<p>MARINE Removal of marine growth, barnacles, loose paint and rust on ship hulls, docks, ballasts, platforms, condensers, floating drydocks, anchor chains, storage tanks and boilers; underwater cleaning of pipes and drilling platforms, of barnacles and marine growth to 'white metal'; coatings removal prior to repainting; draining of sludge and sediments from cargo holds, ballast tanks and double bottoms; surface preparation.</p>	<p>350 - 2.800 (5.000 - 40.000)</p>	

Application	Bar (Psi)	Bar (Psi)
 <p>MILITARY Airport cleaning, nuclear decontamination, cleaning navy applications, wheel and tracked vehicles, rehabilitation and/or decommissioning of concrete installations, cold cutting of ammunition and armoured tanks in decommissioned sites.</p>		<p>700 - 2.800 (10.000 - 40.000)</p>

HIGH PRESSURE PUMPS FOR AN ENTIRE WORLD OF POSSIBLE APPLICATIONS

Application	Bar (Psi)
<p>MINING Pre-maintenance cleaning of dumpers, drag lines, underground haulage lines and shafts; aids in the recovery of ore; unclog plant machinery due to deposits of coal, rock dust, mud or oils.</p>	<p>100 - 500 (1.500 - 7.000)</p>



Application	Bar (Psi)
<p>MUNICIPALITIES Reservoirs and containers, sewers and drain pipes, sanitation equipment and refuse vehicles; insulators, boiler tubes, vehicles and machinery; surface preparation.</p>	<p>200 - 500 (3.000 - 7.000)</p>

Application	Bar (Psi)
<p>OILFIELDS Paraffin and crude residues from platforms and storage tanks; removal of drilling mud and cement from drill pipes; "cold" cutting.</p>	<p>200 - 2.800 (3.000 - 40.000)</p>



Application	Bar (Psi)
<p>PETROCHEMICAL PROCESSING AND REFINERIES Algae, carbon, scum, soft polymers and asbestos, wax, paraffin, grease and crude residues, water scale, calcium sulphate, chlorides, hard polymers, iron oxide, coke, hard carbon, PVC and PVA in heat exchangers, re-boilers, tanks, reactors, pipes, cooling towers and facilities; "cold" cutting.</p>	<p>350 - 2.800 (5.000 - 40.000)</p>

HIGH PRESSURE PUMPS FOR AN ENTIRE WORLD OF POSSIBLE APPLICATIONS

Application	Bar (Psi)
<p>PHARMACEUTICAL</p> <p>Cleaning of chemicals (liquid and solid) from pipes, kettles, mixers, tubes, heat exchangers, reactors, filters and evaporators.</p>	<p>500 - 2.800 (7.000 - 40.000)</p>



Application	Bar (Psi)
<p>PIPES (INDUSTRIAL)</p> <p>Removal of rust and varnish prior to recoating, dope and oil from pipe threads for inspection, drilling mud and debris in various kinds of pipes (internal); manual or fully automatic test units equipped with plunger pumps for filling and test processes.</p>	<p>100 - 700 (1.500 - 10.000)</p>

Application	Bar (Psi)
<p>POWER STATIONS</p> <p>Nuclear decontamination of fuel capsules, 'U' tube exchangers, flash from pre-heater tubes, hand tools and equipment.</p>	<p>700 - 2.800 (10.000 - 40.000)</p>





Application	Bar (Psi)
<p>PRESSURE TESTING</p> <p>Manual or fully automatic test benches up to 7.000 bar used for pressure testing of valves, tubings, hoses, fittings and complete systems.</p>	<p>400 - 7.000 (6.000 - 100.000)</p>

HIGH PRESSURE PUMPS FOR AN ENTIRE WORLD OF POSSIBLE APPLICATIONS

Application	Bar (Psi)	
<p>PULP & PAPER Cleaning of grease, oil, pitch, dirt and wood pulp from heat exchangers, tubes, foundries, press sections of paper machines, suction rolls, stock chests and lines; water jet cutting.</p>	<p>350 - 700 (5.000 - 10.000)</p>	

Application	Bar (Psi)	Bar (Psi)
 <p>RAILWAYS Gypsum, potash, cement, lime in hopper cars; removing grease, dirt and deposits from trucks, undercarriages and tank cars; removal of leaf mulch from railway lines.</p>		<p>350 - 2.800 (5.000 - 40.000)</p>

Application	Bar (Psi)	
<p>RUBBER PROCESSING Latex, SBR and water scale in reactors, storage tanks, heat exchangers, tubing, pipes and facilities.</p>	<p>600 - 2.800 (9.000 - 40.000)</p>	

Application	Bar (Psi)	Bar (Psi)
 <p>TRAFFIC AND TRANSPORTS Removal of road markings, cleaning of railway carriages and buses, renovation of concrete surfaces; cleaning of grease, vegetation, mud, tar, cement or asphalt on vehicles and machinery; graffiti, stains, tar and mastics on concrete bridges and overpasses, removal of expansion joints and paint strips; unblock culverts on bridges and clean up overspill.</p>		<p>350 - 1.000 (5.000 - 15.000)</p>



NOTE





Follow us on



Comet Spa › via G. Dorso, 4 - 42124 Reggio Emilia › Italy › phone + 39 0522 386111 › www.hpp-pressurepumps.com
 Italia: vendite@comet.re.it › Fax + 39 0522 386300
 Export: export@comet.re.it › Fax + 39 0522 386280



COMPANY WITH
 QUALITY SYSTEM
 CERTIFIED BY DNV GL
 = ISO 9001 =

Distributed by: / Distribuito da:
P.T.C. Srl › via Mantegna, 4 - 42048 Rubiera (RE) - Italy
 Phone: +39 0522/1932911 › Fax: +39 0522/1932922
 mail: info@ptcitaliana.com › website: www.ptcitaliana.com